

REV.	MARK	MODIFY DES.	ECN NO.	DR.	DATE
A/0		THE FIRST RELEASE		Peter chen	2008/06/12
A/1	△	design change		Peter chen	2008/06/28

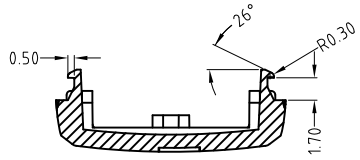

截面B-B

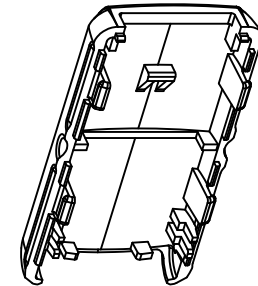
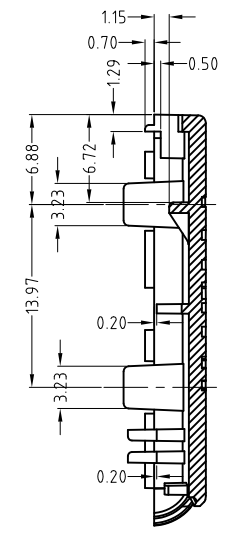
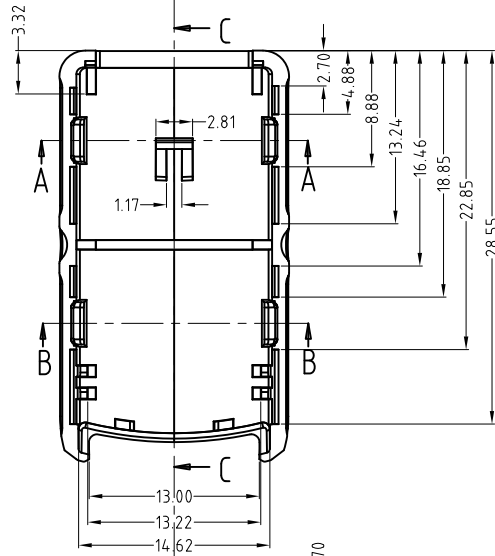
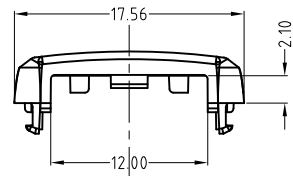
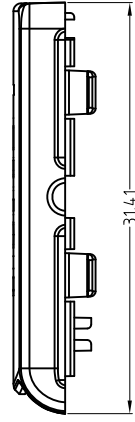
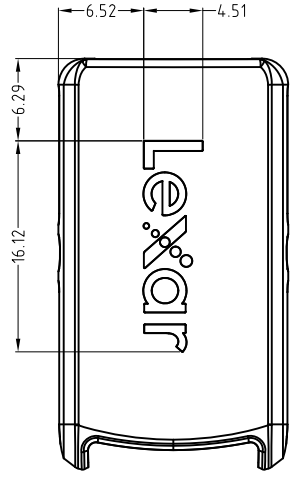
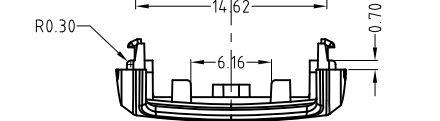

截面A-A

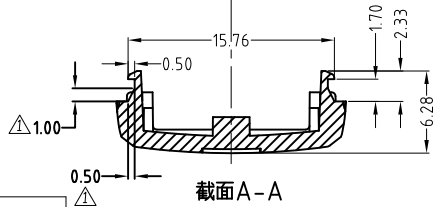

- NOTES:
 1. Material: PC+ABS GE C6200
 2. Burr 0.1 max.
 3. general tolerance ±0.15mm

NO	COLOR	
1	blue	144207-00ATG050
2	red	144207-00ATG060
3	purple	144207-00ATG070
4	green	144207-00ATG080
5	black	144207-00ATG090
6	white	144207-00ATG100

 ATERGI TECHNOLOGY CO; LTD.		TITLE: FIREFLY UPPER CASE		
		DR: Peter chen	FILE NO: ATG-0608	MATERIAL: PC+ABS
GENERAL TOL.	ANGLE TOL.	CHKD:	DWG NO: ATG-060801	SCALE: 0.4
X ± 0.20	X° ±	APPD: jack	P/N: SEE TABLE	UNITS: mm
.X ± 0.15	.X° ± 3°	DATE:	PROJECT	SHEET: 1 OF 1
.XX ± 0.10	.XX° ± 2°	DRAFT WHERE APPLICABLE MUST REMAIN WITHIN DIMENSIONS TOLERANCES		